

MEC COMPACT ENCLOSURES

VỎ TỦ ĐIỆN LOẠI NHỎ MEC

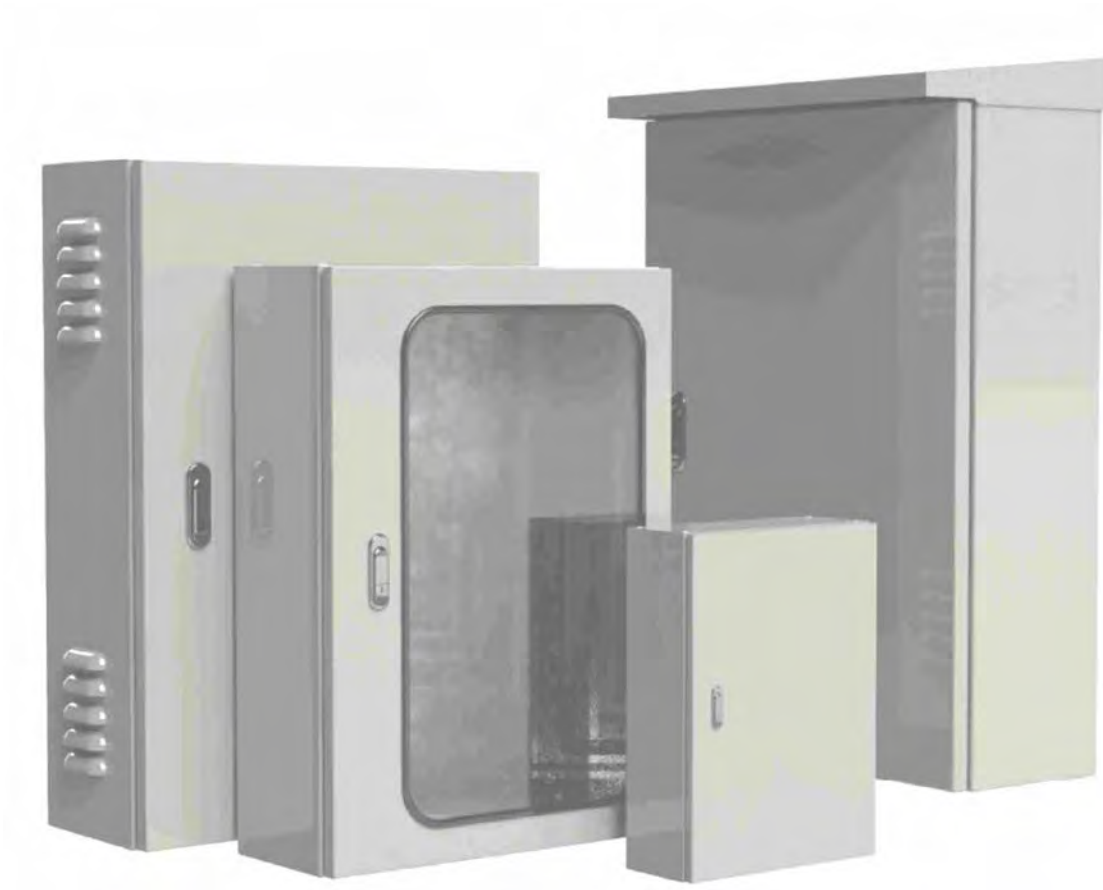

POWER AND AUTOMATION SOLUTIONS



MEE MECHANICAL ELECTRICAL ENGINEERING JSC
CÔNG TY CỔ PHẦN KỸ THUẬT CƠ ĐIỆN MEE

<https://mee.com.vn>

**INDEX - MỤC LỤC**

STT No.	NỘI DUNG	DESCRIPTION	TRANG PAGE
1	General information	Thông tin chung	3
2	Main characteristics	Các đặc điểm chính	4
3	Structures of MEC enclosures	Cấu trúc vỏ tủ MEC	5
4	Blind enclosure MEC	Vỏ tủ trơn MEC	6
5	Cable flange enclosure MEC	Vỏ tủ ra cáp MEC	7
6	Vented enclosure MEC	Vỏ tủ thông gió MEC	8
7	Blind enclosure MEC, stainless steel 304	Vỏ tủ trơn MEC, inox 304	9
8	Cable flange enclosure MEC, stainless steel 304	Vỏ tủ ra cáp MEC, inox 304	10
9	Internal mounting plate	Tấm thiết bị bên trong	11
10	Inner door	Cửa trong	11
11	DIN rail kit	Kit lắp DIN rail	12
12	Accessories	Phụ kiện	13

GENERAL INFORMATION

The range of MEC enclosures is a complete offer of monoblock enclosures for assembling small and medium-sized electrical automation panels, control panels and switchboards.

The typical use of MEC Enclosures is to assemble control panels for a very wide variety of industrial machines: from large machinery with automated production lines or parts of these, down to the typical installations of on-board machine switchboards, boilers, heating plants and so on.

The MEC Enclosures can be also used for assembling the secondary distribution boards, due to the possibility, when using 400, 600, 800 and 1000 mm widths, of installing the whole range of apparatus and modular circuit-breakers on DIN rails combined with special pre-drilled and hinged modular front panels, allowing construction distribution switchboards thanks to the availability of a series of accessories (modular panels, DIN rails).

THÔNG TIN CHUNG

Vỏ tủ điện MEC cung cấp đầy đủ các tủ loại đơn, nhỏ gọn để lắp đặt các tủ điện phân phối, điều khiển và tự động hóa vừa và nhỏ.

Công dụng điển hình của tủ MEC là chế tạo tủ điều khiển cho rất nhiều loại máy công nghiệp: từ máy móc lớn với dây chuyền sản xuất tự động hoặc các bộ phận của chúng, cho đến lắp đặt điển hình tủ chính của máy, nồi hơi, lò đốt,.. vv.

Tủ MEC cũng cho phép lắp đặt các tủ phân phối thứ cấp trong các tủ có chiều rộng 400mm, 600mm, 800mm, 1000mm lắp đặt toàn bộ thiết bị trên các tấm thiết bị và bộ ngắt mạch mô-đun trên thanh ray DIN kết hợp với các lỗ cắt mặt trước hoặc trên cửa modul. Lắp đặt các tủ điện phân phối dễ dàng nhờ các phụ kiện lắp đặt có sẵn (Tấm thiết bị, thanh ray DIN).

Blind Enclosures
with blind door

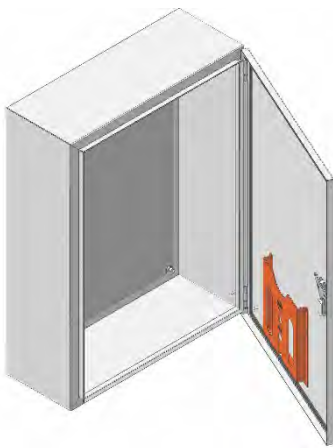

Cable flange Enclosures
with blind door

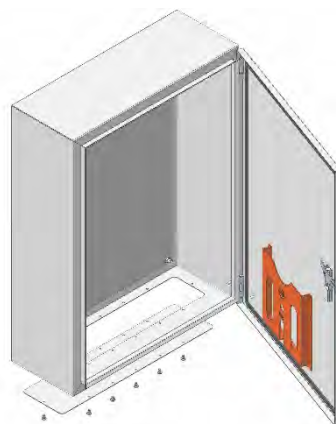

Vented Enclosures
with blind door

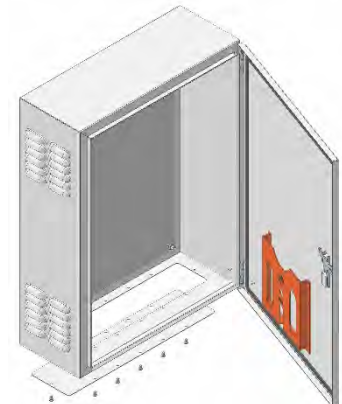

MAIN CHARACTERISTICS

Standard	Conformity with the Standard IEC 61439-1-2
Rated service voltage U_e	up to 690VAC
Rated insulation voltage U_i	up to 1000V AC
Rated frequency	50-60 Hz
IP protection class	IP41, IP43, IP55, IP65
IK mechanical resistance	IK09-IK10
Segregation Form	up to form 2b
Type of material	Metallic
Overall dimensions	
Height (mm)	300, 400, 500, 600, 700, 800, 1000, 1200mm
Width (mm)	200, 300, 400, 600, 800, 1000mm
Depth (mm)	150, 210, 250, 300mm

CÁC ĐẶC ĐIỂM CHÍNH

<i>Tiêu chuẩn</i>	<i>Phù hợp với tiêu chuẩn IEC 61439-1-2</i>
<i>Điện áp định mức U_e</i>	<i>Đến 690VAC</i>
<i>Điện áp cách điện U_i</i>	<i>Đến 1000V AC</i>
<i>Tần số định mức</i>	<i>50-60 Hz</i>
<i>Cấp bảo vệ IP</i>	<i>IP41, IP43, IP54, IP65</i>
<i>Độ bền cơ học</i>	<i>IK09-IK10</i>
<i>Form tủ</i>	<i>Đến form 2b</i>
<i>Loại vật liệu</i>	<i>Thép sơn tĩnh điện, Inox 304, Inox 316</i>
<i>Kích thước ngoài</i>	
<i>Cao (mm)</i>	<i>300, 400, 500, 600, 700, 800, 1000, 1200mm</i>
<i>Rộng (mm)</i>	<i>200, 300, 400, 600, 800, 1000mm</i>
<i>Sâu (mm)</i>	<i>150, 210, 250, 300mm</i>

On request of customers

- Special size
- Special color
- Pre-punching
- Complementary Options

Theo yêu cầu của khách hàng

- kích thước đặc biệt
- màu đặc biệt
- đục lỗ trước
- Tùy chọn bổ sung

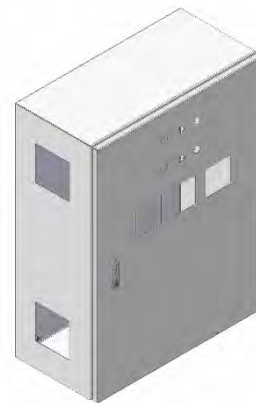

STRUCTURES OF MEC ENCLOSURES CẤU TRÚC VỎ TỦ MEC

Blind Enclosures

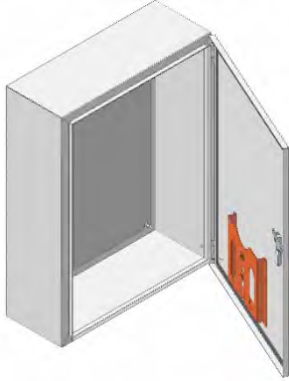

Cable Enclosures

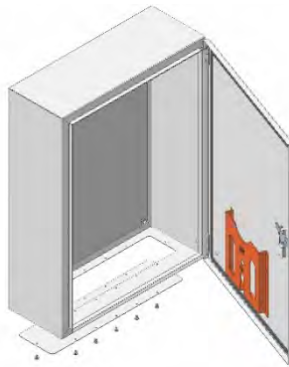

Vented Enclosures

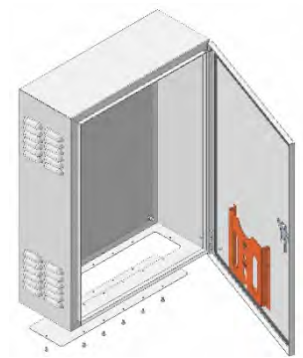

Mounting plate.

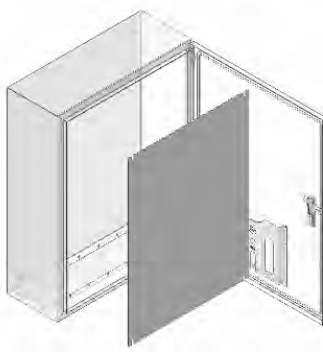

Inner doors

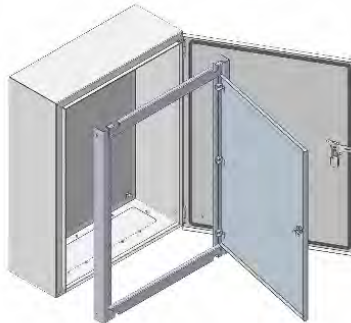

DIN rail Kit modules

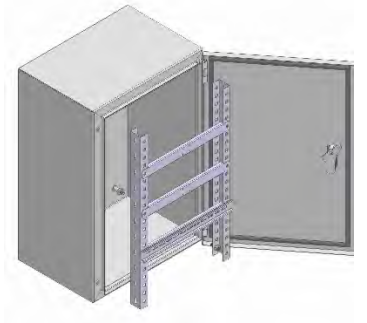

Spray protection roofs



Plastic diagram holder pocket A4

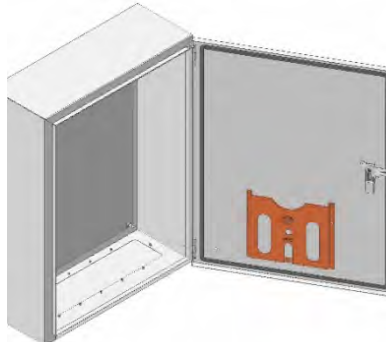

Brackets for wall fixing

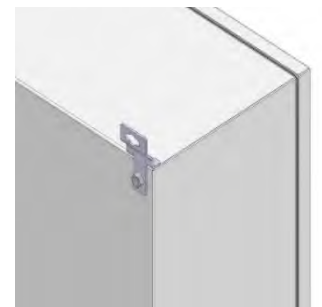

BLIND ENCLOSURE MEC VỎ TỦ TRƠN MEC

Supply Includes:

- 1 Blind enclosure body in steel sheet, painted RAL 7035
- 1 Blind door in steel sheet, painted RAL 7035
- 1 Mounting plate in Ecogal or Zam steel

Cung cấp bao gồm:

- 1 Thân tủ trơn bằng thép, sơn RAL 7035
- 1 Cửa tủ trơn bằng thép, sơn RAL 7035
- 1 Tấm lắp thiết bị bằng thép Ecogal hoặc Zam

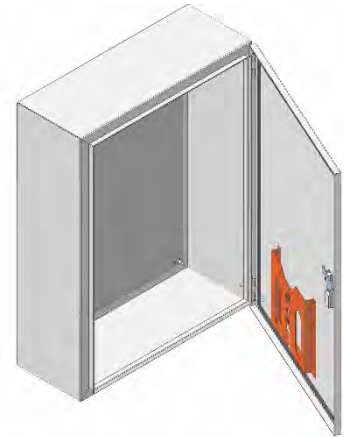

Dimensions (mm)			Order codes			
H	W	D	1.0mm steel sheet	1.2mm steel sheet	1.5mm steel sheet	2.0mm steel sheet
300	200	150	MECAB030215M10E15	MECAB030215M12E15	MECAB030215M15E20	MECAB030215M20E20
300	300	150	MECAB030315M10E15	MECAB030315M12E15	MECAB030315M15E20	MECAB030315M20E20
400	300	150	MECAB040315M10E15	MECAB040315M12E15	MECAB040315M15E20	MECAB040315M20E20
400	300	210	MECAB040321M10E15	MECAB040321M12E15	MECAB040321M15E20	MECAB040321M20E20
400	400	210	MECAB040421M10E15	MECAB040421M12E15	MECAB040421M15E20	MECAB040421M20E20
500	300	210	MECAB050321M10E15	MECAB050321M12E15	MECAB050321M15E20	MECAB050321M20E20
500	400	210	MECAB050421M10E15	MECAB050421M12E15	MECAB050421M15E20	MECAB050421M20E20
500	400	250	MECAB050425M10E15	MECAB050425M12E15	MECAB050425M15E20	MECAB050425M20E20
600	400	210	MECAB060421M10E15	MECAB060421M12E15	MECAB060421M15E20	MECAB060421M20E20
600	400	250	MECAB060425M10E15	MECAB060425M12E15	MECAB060425M15E20	MECAB060425M20E20
600	600	250	MECAB060625M10E15	MECAB060625M12E15	MECAB060625M15E20	MECAB060625M20E20
700	500	210	MECAB070521M10E15	MECAB070521M12E15	MECAB070521M15E20	MECAB070521M20E20
700	500	250	MECAB070525M10E15	MECAB070525M12E15	MECAB070525M15E20	MECAB070525M20E20
800	600	250	MECAB080625M10E15	MECAB080625M12E15	MECAB080625M15E20	MECAB080625M20E20
800	600	300	MECAB080630M10E15	MECAB080630M12E15	MECAB080630M15E20	MECAB080630M20E20
800	800	300	MECAB080830M10E15	MECAB080830M12E15	MECAB080830M15E20	MECAB080830M20E20
1000	600	250			MECAB100625M15E20	MECAB100625M20E20
1000	600	300			MECAB100630M15E20	MECAB100630M20E20
1000	800	300			MECAB100830M15E20	MECAB100830M20E20
1200	600	300			MECAB120630M15E20	MECAB120630M20E20
1200	800	300			MECAB120830M15E20	MECAB120830M20E20
1200	1000	300			MECAB121030M15E20	MECAB121030M20E20

CABLE FLANGE ENCLOSURE MEC VỎ TỦ RA CÁP MEC

Supply Includes:

- 1 Cable flange enclosure body in steel sheet, painted RAL 7035
- 1 Blind door in steel sheet, painted RAL 7035
- 1 Mounting plate in Ecogal or Zam steel

Cung cấp bao gồm:

- 1 Thân tủ ra cáp bằng thép, sơn RAL 7035
- 1 Cửa tủ tron bằng thép, sơn RAL 7035
- 1 Tấm lắp thiết bị bằng thép Ecogal hoặc Zam

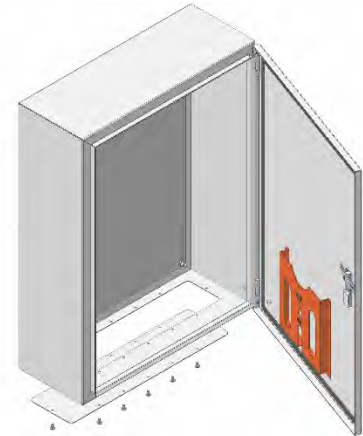

Dimensions (mm)			Order codes			
H	W	D	1.0mm steel sheet	1.2mm steel sheet	1.5mm steel sheet	2.0mm steel sheet
300	200	150	MECAC030215M10E15	MECAC030215M12E15	MECAC030215M15E20	MECAC030215M20E20
300	300	150	MECAC030315M10E15	MECAC030315M12E15	MECAC030315M15E20	MECAC030315M20E20
400	300	150	MECAC040315M10E15	MECAC040315M12E15	MECAC040315M15E20	MECAC040315M20E20
400	300	210	MECAC040321M10E15	MECAC040321M12E15	MECAC040321M15E20	MECAC040321M20E20
400	400	210	MECAC040421M10E15	MECAC040421M12E15	MECAC040421M15E20	MECAC040421M20E20
500	300	210	MECAC050321M10E15	MECAC050321M12E15	MECAC050321M15E20	MECAC050321M20E20
500	400	210	MECAC050421M10E15	MECAC050421M12E15	MECAC050421M15E20	MECAC050421M20E20
500	400	250	MECAC050425M10E15	MECAC050425M12E15	MECAC050425M15E20	MECAC050425M20E20
600	400	210	MECAC060421M10E15	MECAC060421M12E15	MECAC060421M15E20	MECAC060421M20E20
600	400	250	MECAC060425M10E15	MECAC060425M12E15	MECAC060425M15E20	MECAC060425M20E20
600	600	250	MECAC060625M10E15	MECAC060625M12E15	MECAC060625M15E20	MECAC060625M20E20
700	500	210	MECAC070521M10E15	MECAC070521M12E15	MECAC070521M15E20	MECAC070521M20E20
700	500	250	MECAC070525M10E15	MECAC070525M12E15	MECAC070525M15E20	MECAC070525M20E20
800	600	250	MECAC080625M10E15	MECAC080625M12E15	MECAC080625M15E20	MECAC080625M20E20
800	600	300	MECAC080630M10E15	MECAC080630M12E15	MECAC080630M15E20	MECAC080630M20E20
800	800	300	MECAC080830M10E15	MECAC080830M12E15	MECAC080830M15E20	MECAC080830M20E20
1000	600	250			MECAC100625M15E20	MECAC100625M20E20
1000	600	300			MECAC100630M15E20	MECAC100630M20E20
1000	800	300			MECAC100830M15E20	MECAC100830M20E20
1200	600	300			MECAC120630M15E20	MECAC120630M20E20
1200	800	300			MECAC120830M15E20	MECAC120830M20E20
1200	1000	300			MECAC121030M15E20	MECAC121030M20E20

VENTED ENCLOSURE MEC VỎ TỦ THÔNG GIÓ MEC

Supply Includes:

- 1 Vented enclosure body in steel sheet, painted RAL 7035
- 1 Blind door in steel sheet, painted RAL 7035
- 1 Mounting plate in Ecogal or Zam steel

Cung cấp bao gồm:

- 1 Thân tủ thông gió bằng thép, sơn RAL 7035
- 1 Cửa tủ trơn bằng thép, sơn RAL 7035
- 1 Tấm lắp thiết bị bằng thép Ecogal hoặc Zam

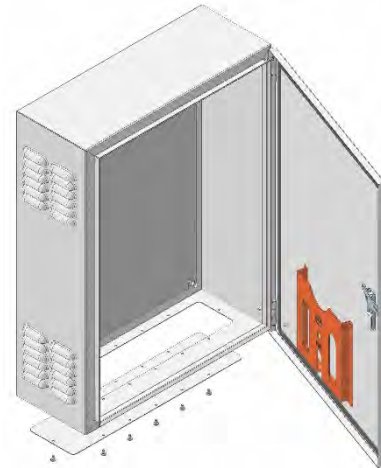

Dimensions (mm)			Order codes			
H	W	D	1.0mm steel sheet	1.2mm steel sheet	1.5mm steel sheet	2.0mm steel sheet
300	200	150	MECAV030215M10E15	MECAV030215M12E15	MECAV030215M15E20	MECAV030215M20E20
300	300	150	MECAV030315M10E15	MECAV030315M12E15	MECAV030315M15E20	MECAV030315M20E20
400	300	150	MECAV040315M10E15	MECAV040315M12E15	MECAV040315M15E20	MECAV040315M20E20
400	300	210	MECAV040321M10E15	MECAV040321M12E15	MECAV040321M15E20	MECAV040321M20E20
400	400	210	MECAV040421M10E15	MECAV040421M12E15	MECAV040421M15E20	MECAV040421M20E20
500	300	210	MECAV050321M10E15	MECAV050321M12E15	MECAV050321M15E20	MECAV050321M20E20
500	400	210	MECAV050421M10E15	MECAV050421M12E15	MECAV050421M15E20	MECAV050421M20E20
500	400	250	MECAV050425M10E15	MECAV050425M12E15	MECAV050425M15E20	MECAV050425M20E20
600	400	210	MECAV060421M10E15	MECAV060421M12E15	MECAV060421M15E20	MECAV060421M20E20
600	400	250	MECAV060425M10E15	MECAV060425M12E15	MECAV060425M15E20	MECAV060425M20E20
600	600	250	MECAV060625M10E15	MECAV060625M12E15	MECAV060625M15E20	MECAV060625M20E20
700	500	210	MECAV070521M10E15	MECAV070521M12E15	MECAV070521M15E20	MECAV070521M20E20
700	500	250	MECAV070525M10E15	MECAV070525M12E15	MECAV070525M15E20	MECAV070525M20E20
800	600	250	MECAV080625M10E15	MECAV080625M12E15	MECAV080625M15E20	MECAV080625M20E20
800	600	300	MECAV080630M10E15	MECAV080630M12E15	MECAV080630M15E20	MECAV080630M20E20
800	800	300	MECAV080830M10E15	MECAV080830M12E15	MECAV080830M15E20	MECAV080830M20E20
1000	600	250			MECAV100625M15E20	MECAV100625M20E20
1000	600	300			MECAV100630M15E20	MECAV100630M20E20
1000	800	300			MECAV100830M15E20	MECAV100830M20E20
1200	600	300			MECAV120630M15E20	MECAV120630M20E20
1200	800	300			MECAV120830M15E20	MECAV120830M20E20
1200	1000	300			MECAV121030M15E20	MECAV121030M20E20

BLIND ENCLOSURE MEC, STAINLESS STEEL 304

VỎ TỦ TRƠN MEC, INOX 304

Supply Includes:

- 1 Blind enclosure body in stainless steel 304
- 1 Blind door in stainless steel 304
- 1 Mounting plate in stainless steel 304

Cung cấp bao gồm:

- 1 Thân tủ trơn bằng inox 304
- 1 Cửa tủ trơn bằng inox 304
- 1 Tấm lắp thiết bị bằng inox 304

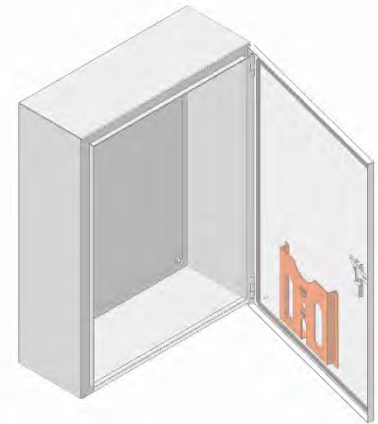

Dimensions (mm)			Order codes			
H	W	D	1.0mm stainless steel	1.2mm stainless steel	1.5mm stainless steel	2.0mm stainless steel
300	200	150	MECAB030215S410S415	MECAB030215S412S415	MECAB030215S415S420	MECAB030215S420S420
300	300	150	MECAB030315S410S415	MECAB030315S412S415	MECAB030315S415S420	MECAB030315S420S420
400	300	150	MECAB040315S410S415	MECAB040315S412S415	MECAB040315S415S420	MECAB040315S420S420
400	300	210	MECAB040321S410S415	MECAB040321S412S415	MECAB040321S415S420	MECAB040321S420S420
400	400	210	MECAB040421S410S415	MECAB040421S412S415	MECAB040421S415S420	MECAB040421S420S420
500	300	210	MECAB050321S410S415	MECAB050321S412S415	MECAB050321S415S420	MECAB050321S420S420
500	400	210	MECAB050421S410S415	MECAB050421S412S415	MECAB050421S415S420	MECAB050421S420S420
500	400	250	MECAB050425S410S415	MECAB050425S412S415	MECAB050425S415S420	MECAB050425S420S420
600	400	210	MECAB060421S410S415	MECAB060421S412S415	MECAB060421S415S420	MECAB060421S420S420
600	400	250	MECAB060425S410S415	MECAB060425S412S415	MECAB060425S415S420	MECAB060425S420S420
600	600	250	MECAB060625S410S415	MECAB060625S412S415	MECAB060625S415S420	MECAB060625S420S420
700	500	210	MECAB070521S410S415	MECAB070521S412S415	MECAB070521S415S420	MECAB070521S420S420
700	500	250	MECAB070525S410S415	MECAB070525S412S415	MECAB070525S415S420	MECAB070525S420S420
800	600	250	MECAB080625S410S415	MECAB080625S412S415	MECAB080625S415S420	MECAB080625S420S420
800	600	300	MECAB080630S410S415	MECAB080630S412S415	MECAB080630S415S420	MECAB080630S420S420
800	800	300	MECAB080830S410S415	MECAB080830S412S415	MECAB080830S415S420	MECAB080830S420S420
1000	600	250			MECAB100625S415S420	MECAB100625S420S420
1000	600	300			MECAB100630S415S420	MECAB100630S420S420
1000	800	300			MECAB100830S415S420	MECAB100830S420S420
1200	600	300			MECAB120630S415S420	MECAB120630S420S420
1200	800	300			MECAB120830S415S420	MECAB120830S420S420
1200	1000	300			MECAB121030S415S420	MECAB121030S420S420

CABLE FLANGE ENCLOSURE MEC, STAINLESS STEEL 304

VỎ TỦ RA CÁP MEC, INOX 304

Supply Includes:

- 1 Cable flange enclosure body in stainless steel 304
- 1 Blind door in stainless steel 304
- 1 Mounting plate in stainless steel 304

Cung cấp bao gồm:

- 1 Thân tủ ra cáp bằng inox 304
- 1 Cửa tủ trơn bằng inox 304
- 1 Tấm lắp thiết bị bằng inox 304

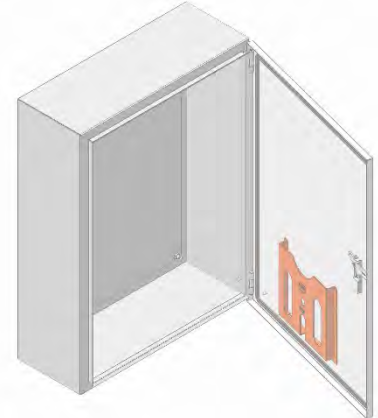

Dimensions (mm)			Order codes			
H	W	D	1.0mm stainless steel	1.2mm stainless steel	1.5mm stainless steel	2.0mm stainless steel
300	200	150	MECAC030215S410S415	MECAC030215S412S415	MECAC030215S415S420	MECAC030215S420S420
300	300	150	MECAC030315S410S415	MECAC030315S412S415	MECAC030315S415S420	MECAC030315S420S420
400	300	150	MECAC040315S410S415	MECAC040315S412S415	MECAC040315S415S420	MECAC040315S420S420
400	300	210	MECAC040321S410S415	MECAC040321S412S415	MECAC040321S415S420	MECAC040321S420S420
400	400	210	MECAC040421S410S415	MECAC040421S412S415	MECAC040421S415S420	MECAC040421S420S420
500	300	210	MECAC050321S410S415	MECAC050321S412S415	MECAC050321S415S420	MECAC050321S420S420
500	400	210	MECAC050421S410S415	MECAC050421S412S415	MECAC050421S415S420	MECAC050421S420S420
500	400	250	MECAC050425S410S415	MECAC050425S412S415	MECAC050425S415S420	MECAC050425S420S420
600	400	210	MECAC060421S410S415	MECAC060421S412S415	MECAC060421S415S420	MECAC060421S420S420
600	400	250	MECAC060425S410S415	MECAC060425S412S415	MECAC060425S415S420	MECAC060425S420S420
600	600	250	MECAC060625S410S415	MECAC060625S412S415	MECAC060625S415S420	MECAC060625S420S420
700	500	210	MECAC070521S410S415	MECAC070521S412S415	MECAC070521S415S420	MECAC070521S420S420
700	500	250	MECAC070525S410S415	MECAC070525S412S415	MECAC070525S415S420	MECAC070525S420S420
800	600	250	MECAC080625S410S415	MECAC080625S412S415	MECAC080625S415S420	MECAC080625S420S420
800	600	300	MECAC080630S410S415	MECAC080630S412S415	MECAC080630S415S420	MECAC080630S420S420
800	800	300	MECAC080830S410S415	MECAC080830S412S415	MECAC080830S415S420	MECAC080830S420S420
1000	600	250			MECAC100625S415S420	MECAC100625S420S420
1000	600	300			MECAC100630S415S420	MECAC100630S420S420
1000	800	300			MECAC100830S415S420	MECAC100830S420S420
1200	600	300			MECAC120630S415S420	MECAC120630S420S420
1200	800	300			MECAC120830S415S420	MECAC120830S420S420
1200	1000	300			MECAC121030S415S420	MECAC121030S420S420

INTERNAL MOUNTING PLATE TẤM THIẾT BỊ BÊN TRONG

Supply Includes:

- 1 Mounting plate in Ecogal steel or Zam steel

Cung cấp bao gồm:

- 1 Tấm lắp thiết bị bằng thép Ecogal hoặc thép Zam

Dimensions (mm)		Order codes	
H	W	1.5mm Zam steel	2.0mm Zam steel
300	200	MECKPB0302E15	MECKPB0302E20
	300	MECKPB0303E15	MECKPB0303E20
	400	MECKPB0304E15	MECKPB0304E20
400	300	MECKPB0403E15	MECKPB0403E20
	400	MECKPB0404E15	MECKPB0404E20
	600	MECKPB0406E15	MECKPB0406E20
500	300	MECKPB0503E15	MECKPB0503E20
	400	MECKPB0504E15	MECKPB0504E20
	500	MECKPB0505E15	MECKPB0505E20
	600	MECKPB0506E15	MECKPB0506E20
600	400	MECKPB0604E15	MECKPB0604E20
	600	MECKPB0606E15	MECKPB0606E20
800	600	MECKPB0806E15	MECKPB0806E20
	800	MECKPB0808E15	MECKPB0808E20
1000	600	MECKPB1006E15	MECKPB1006E20
	800	MECKPB1008E15	MECKPB1008E20
1200	600	MECKPB1206E15	MECKPB1206E20
	800	MECKPB1208E15	MECKPB1208E20
	1000	MECKPB1210E15	MECKPB1210E20

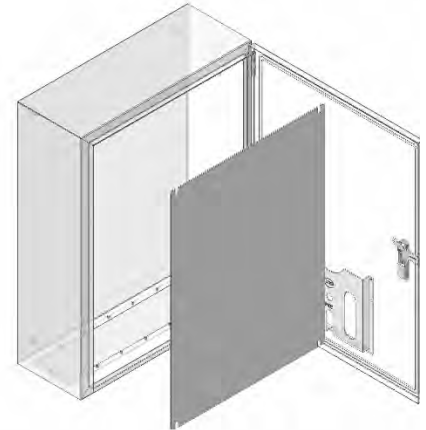

INNER DOOR CỬA TRONG

Supply Includes:

- 1 Inner door in steel sheet, painted RAL 7035 and assembly parts

Cung cấp bao gồm:

- 1 Cửa trong bằng thép, sơn RAL 7035 và phụ kiện lắp đặt

Dimensions (mm)		Order codes		
H	W	1.0mm steel sheet	1.2mm steel sheet	1.5mm steel sheet
400	400	MECKDB0404M10	MECKDB0404M12	MECKDB0404M15
	600	MECKDB0406M10	MECKDB0406M12	MECKDB0406M15
500	400	MECKDB0504M10	MECKDB0504M12	MECKDB0504M15
	600	MECKDB0506M10	MECKDB0506M12	MECKDB0506M15
600	400	MECKDB0604M10	MECKDB0604M12	MECKDB0604M15
	600	MECKDB0606M10	MECKDB0606M12	MECKDB0606M15
800	600	MECKDB0806M10	MECKDB0806M12	MECKDB0806M15
	800	MECKDB0808M10	MECKDB0808M12	MECKDB0808M15
1000	600			MECKDB1006M15
	800			MECKDB1008M15
1200	600			MECKDB1206M15
	800			MECKDB1208M15
	1000			MECKDB1210M15

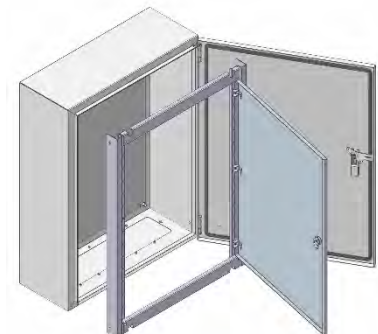

DIN RAIL KIT

KÍT LẮP DIN RAIL

Supply Includes:

- 1 DIN rail kit in Ecogal steel or Zam steel

Cung cấp bao gồm:

- 1 Kít lắp DIN rail bằng thép Ecogal hoặc thép Zam

Dimensions (mm)		Order codes	Description
H	W		
400	400	MECDK0404	Interior kit for DIN rails MEC 400x400
	600	MECDK0406	Interior kit for DIN rails MEC 400x600
500	400	MECDK0504	Interior kit for DIN rails MEC 500x400
	600	MECDK0506	Interior kit for DIN rails MEC 500x600
600	400	MECDK0604	Interior kit for DIN rails MEC 600x400
	600	MECDK0606	Interior kit for DIN rails MEC 600x600
800	600	MECDK0806	Interior kit for DIN rails MEC 800x600
	800	MECDK0808	Interior kit for DIN rails MEC 800x800
1000	600	MECDK1006	Interior kit for DIN rails MEC 1000x600
	800	MECDK1008	Interior kit for DIN rails MEC 1000x800
1200	600	MECDK1206	Interior kit for DIN rails MEC 1200x600
	800	MECDK1208	Interior kit for DIN rails MEC 1200x800
	1000	MECDK1210	Interior kit for DIN rails MEC 1200x1000

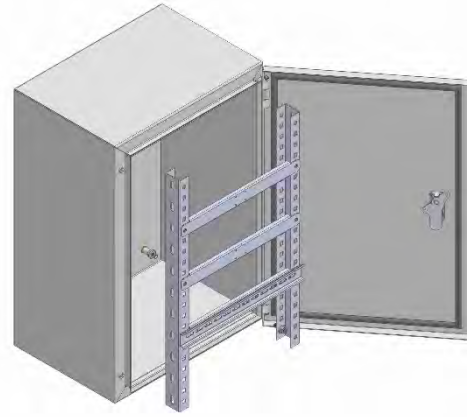

ACCESSORIES PHỤ KIỆN

Spray protection roofs – Mái che bảo vệ

Supply Includes:

- 1 pcs spray protection roofs and assembly parts, painted RAL 7035

Cung cấp bao gồm:

- 01 mái che bảo vệ và phụ kiện lắp đặt, sơn RAL 7035

Dimensions (mm)		Order codes			
W	D	1.0mm steel sheet	1.2mm steel sheet	1.5mm steel sheet	2.0mm steel sheet
200	150	MECERP0215M10	MECERP0215M12	MECERP0215M15	MECERP0215M20
300		MECERP0315M10	MECERP0315M12	MECERP0315M15	MECERP0315M20
400		MECERP0415M10	MECERP0415M12	MECERP0415M15	MECERP0415M20
300	210	MECERP0321M10	MECERP0321M12	MECERP0321M15	MECERP0321M20
400		MECERP0421M10	MECERP0421M12	MECERP0421M15	MECERP0421M20
600		MECERP0621M10	MECERP0621M12	MECERP0621M15	MECERP0621M20
800		MECERP0821M10	MECERP0821M12	MECERP0821M15	MECERP0821M20
400	250	MECERP0425M10	MECERP0425M12	MECERP0425M15	MECERP0425M20
600		MECERP0625M10	MECERP0625M12	MECERP0625M15	MECERP0625M20
800		MECERP0825M10	MECERP0825M12	MECERP0825M15	MECERP0825M20
1000				MECERP1025M15	MECERP1025M20
600	300	MECERP0630M10	MECERP0630M12	MECERP0630M15	MECERP0630M20
800		MECERP0830M10	MECERP0830M12	MECERP0830M15	MECERP0830M20
1000				MECERP1030M15	MECERP1030M20



Document pocket – Túi đựng hồ sơ

Supply Includes:

- 1 pcs document pocket made of plastic, Orange color, A4 size.

Cung cấp bao gồm:

- 1 túi đựng hồ sơ bằng nhựa màu cam khổ A4

Order codes	Description
MEEPA4	Made of plastic, orange color, A4 size.

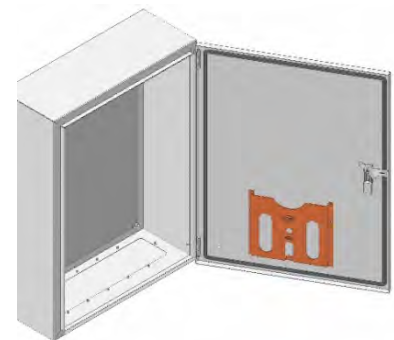

Brackets for wall fixing – Bát treo tường

Supply Includes:

- 4 pcs Brackets for wall fixing

Cung cấp bao gồm:

- 4 bát treo tường

Order codes	Description
MECBW	Brackets for wall fixing

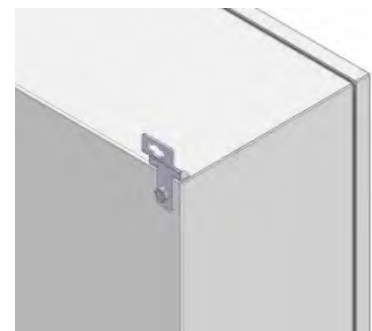



QUALITY
EFFICIENCY
PROFESSIONALISM



CÔNG TY CỔ PHẦN KỸ THUẬT CƠ ĐIỆN MEE

MEE MECHANICAL ELECTRICAL ENGINEERING JSC

Lô HT-E10-6-9, Đường số 19, Khu công
nghiệp Hiệp Phước, Xã Hiệp Phước,
Huyện Nhà Bè, TP. Hồ Chí Minh, Việt Nam
Mã số thuế: 0310439936

Lot HT-E10-6-9, Road 19, Hiep Phuoc
Industrial Park, Hiep Phuoc Commune,
Nha Be Dist., Ho Chi Minh City, Vietnam
Tax code: 0310439936

www.mee.com.vn

+84 938 848 788

info@mee.com.vn